

## PRODUCT FEATURES

- 650V IGBT chip in trench FS-technology
- Low switching losses
- $V_{CE(sat)}$  with positive temperature coefficient
- Fast switching and short tail current
- Free wheeling diodes with fast and soft reverse recovery

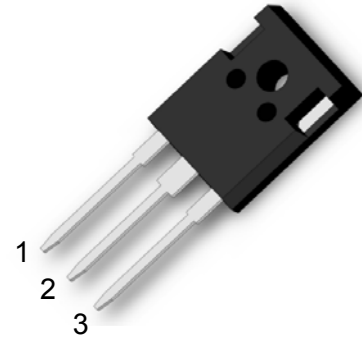

## APPLICATIONS

- High frequency switching application
- Medical applications
- Motion/servo control
- UPS systems

1.Gate  
2.Collector  
3.Emitter



Type	$V_{CES}$	$I_C$	$V_{CE(sat)}$ $T_J=25^\circ C$	$T_{Jmax}$	Marking	Package
MM75G3T65B	650V	75A	1.45V	175°C	MM75G3T65B	TO-247

## ABSOLUTE MAXIMUM RATINGS( $T_C=25^\circ C$ unless otherwise specified)

Symbol	Parameter/Test Conditions	Values	Unit	
$V_{CES}$	Collector Emitter Voltage $T_J=25^\circ C$	650	V	
$V_{GES}$	Gate Emitter Voltage	$\pm 20$		
	Transient Gate Emitter Voltage ( $t_p \leq 10\mu s, D < 0.01$ )	$\pm 30$		
$I_C$	DC Collector Current	$T_C=25^\circ C$	115	
		$T_C=100^\circ C$	75	
$I_{Cpuls}$	Pulsed collector current, $t_p$ limited by $T_{Jmax}$	225	A	
$P_{tot}$	Power Dissipation Per IGBT	535	W	
$V_{RRM}$	Repetitive Reverse Voltage $T_J=25^\circ C$	650	V	
$I_{F(AV)}$	Average Forward Current $T_C=100^\circ C$	75	A	
	Diode pulsed current, $t_p$ limited by $T_{Jmax}$	225		
$T_{Jmax}$	Max. Junction Temperature	175	°C	
$T_{Jop}$	Operating Temperature	-40~175		
$T_{stg}$	Storage Temperature	-55~150		
Torque	to heatsink	Recommended (M3)	1.1	Nm
Weight			8	g

MacMic Science & Technology Co., Ltd.

Add: #18, Hua Shan Zhong Lu, New District, Changzhou City, Jiangsu Province, P. R. of China

Tel.: +86-519-85163708 Fax: +86-519-85162291 Post Code: 213022 Website: www.macmicst.com

# MM75G3T65B

## IGBT

### ELECTRICAL CHARACTERISTICS ( $T_C=25^\circ\text{C}$ unless otherwise specified)

Symbol	Parameter/Test Conditions		Min.	Typ.	Max.	Unit
$V_{GE(th)}$	Gate Emitter Threshold Voltage	$V_{CE}=V_{GE}, I_C=3.0\text{mA}$	4.8	5.6	6.5	V
$V_{CE(sat)}$	Collector Emitter Saturation Voltage	$I_C=75\text{A}, V_{GE}=15\text{V}, T_J=25^\circ\text{C}$		1.45	1.95	
		$I_C=75\text{A}, V_{GE}=15\text{V}, T_J=125^\circ\text{C}$		1.65		
		$I_C=75\text{A}, V_{GE}=15\text{V}, T_J=150^\circ\text{C}$		1.7		
$I_{CES}$	Collector Leakage Current	$V_{CE}=650\text{V}, V_{GE}=0\text{V}, T_J=25^\circ\text{C}$			100	$\mu\text{A}$
		$V_{CE}=650\text{V}, V_{GE}=0\text{V}, T_J=150^\circ\text{C}$			10	$\text{mA}$
$I_{GES}$	Gate Leakage Current	$V_{CE}=0\text{V}, V_{GE}=\pm 20\text{V}, T_J=25^\circ\text{C}$	-200		200	$\text{nA}$
$Q_g$	Gate Charge	$V_{CE}=400\text{V}, I_C=75\text{A}, V_{GE}=15\text{V}$		360		$\text{nC}$
$C_{ies}$	Input Capacitance	$V_{CE}=25\text{V}, V_{GE}=0\text{V}, f=1\text{MHz}$		4.4		$\text{nF}$
$C_{res}$	Reverse Transfer Capacitance				200	$\text{pF}$
$t_{d(on)}$	Turn on Delay Time	$V_{CC}=400\text{V}, I_C=75\text{A}$ $R_G=7.5\Omega,$	$T_J=25^\circ\text{C}$		24	$\text{ns}$
			$T_J=125^\circ\text{C}$		26	$\text{ns}$
			$T_J=150^\circ\text{C}$		26	$\text{ns}$
$t_r$	Rise Time	$V_{GE}=\pm 15\text{V},$ Inductive Load	$T_J=25^\circ\text{C}$		40	$\text{ns}$
			$T_J=125^\circ\text{C}$		42	$\text{ns}$
			$T_J=150^\circ\text{C}$		42	$\text{ns}$
$t_{d(off)}$	Turn off Delay Time	$V_{CC}=400\text{V}, I_C=75\text{A}$ $R_G=7.5\Omega,$	$T_J=25^\circ\text{C}$		190	$\text{ns}$
			$T_J=125^\circ\text{C}$		220	$\text{ns}$
			$T_J=150^\circ\text{C}$		230	$\text{ns}$
$t_f$	Fall Time	$V_{GE}=\pm 15\text{V},$ Inductive Load	$T_J=25^\circ\text{C}$		80	$\text{ns}$
			$T_J=125^\circ\text{C}$		110	$\text{ns}$
			$T_J=150^\circ\text{C}$		120	$\text{ns}$
$E_{on}$	Turn on Energy	$V_{CC}=400\text{V}, I_C=75\text{A}$ $R_G=7.5\Omega,$	$T_J=125^\circ\text{C}$		3	$\text{mJ}$
			$T_J=150^\circ\text{C}$		3.25	$\text{mJ}$
$E_{off}$	Turn off Energy	$V_{GE}=\pm 15\text{V},$ Inductive Load	$T_J=125^\circ\text{C}$		2.9	$\text{mJ}$
			$T_J=150^\circ\text{C}$		3.05	$\text{mJ}$
$I_{SC}$	Short Circuit Current	$t_{psc}\leq 5\mu\text{s}, V_{GE}=15\text{V}$ $T_J=150^\circ\text{C}, V_{CC}=400\text{V}$		395		A
$R_{thJC}$	Junction to Case Thermal Resistance ( Per IGBT)				0.24	$\text{K/W}$

## Anti-Parallel Diode

### ELECTRICAL CHARACTERISTICS ( $T_C=25^\circ\text{C}$ unless otherwise specified)

Symbol	Parameter/Test Conditions		Min.	Typ.	Max.	Unit
$V_F$	Forward Voltage	$I_F=75\text{A}, V_{GE}=0\text{V}, T_J=25^\circ\text{C}$		1.9	2.4	V
		$I_F=75\text{A}, V_{GE}=0\text{V}, T_J=125^\circ\text{C}$		1.7		
		$I_F=75\text{A}, V_{GE}=0\text{V}, T_J=150^\circ\text{C}$		1.65		
$t_{rr}$	Reverse Recovery Time	$I_F=75\text{A}, V_R=400\text{V}$ $dI_F/dt=-1800\text{A}/\mu\text{s}$ $T_J=150^\circ\text{C}$		162		$\text{ns}$
$I_{RRM}$	Max. Reverse Recovery Current			62		A
$Q_{RR}$	Reverse Recovery Charge			5		$\mu\text{C}$
$E_{rec}$	Reverse Recovery Energy			1.25		$\text{mJ}$
$R_{thJCD}$	Junction to Case Thermal Resistance ( Per Diode)				0.48	$\text{K/W}$

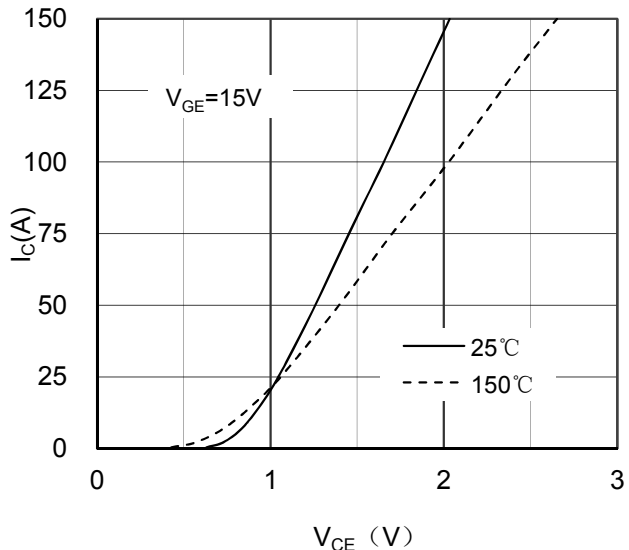

Figure 1. Typical Output Characteristics IGBT

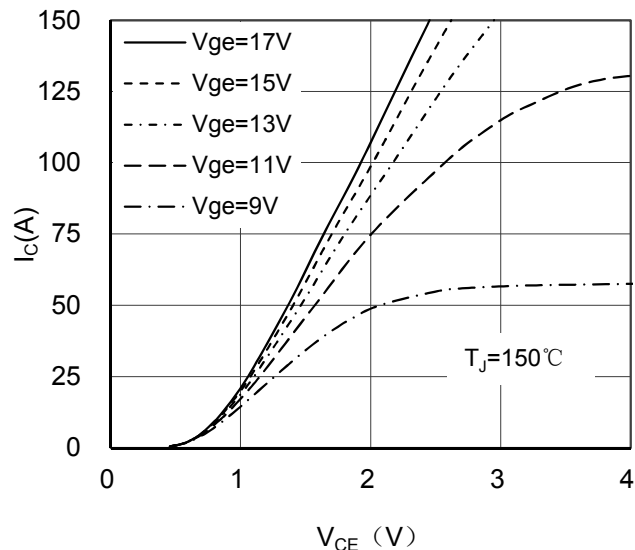

Figure 2. Typical Output Characteristics IGBT

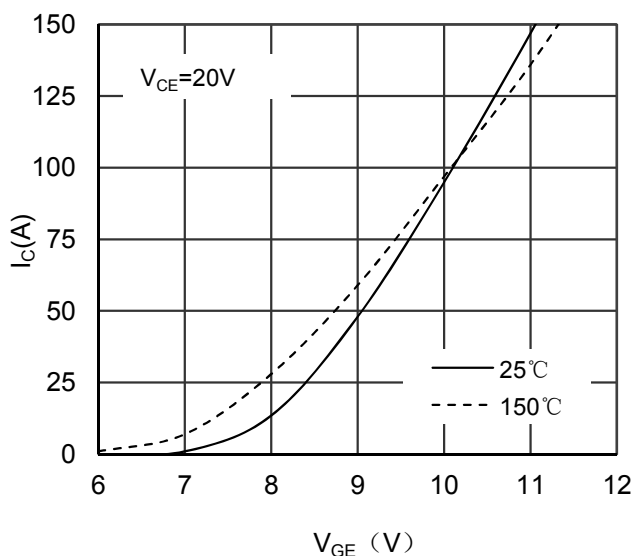

Figure 3. Typical Transfer characteristics IGBT

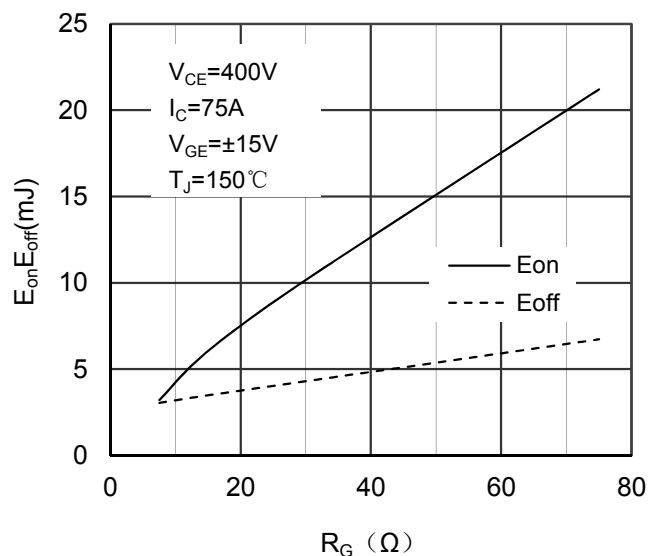

Figure 4. Switching Energy vs Gate Resistor IGBT

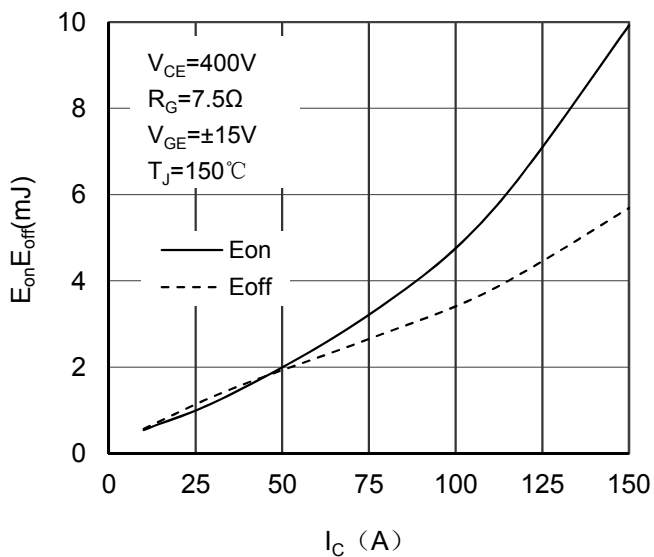

Figure 5. Switching Energy vs Collector Current IGBT

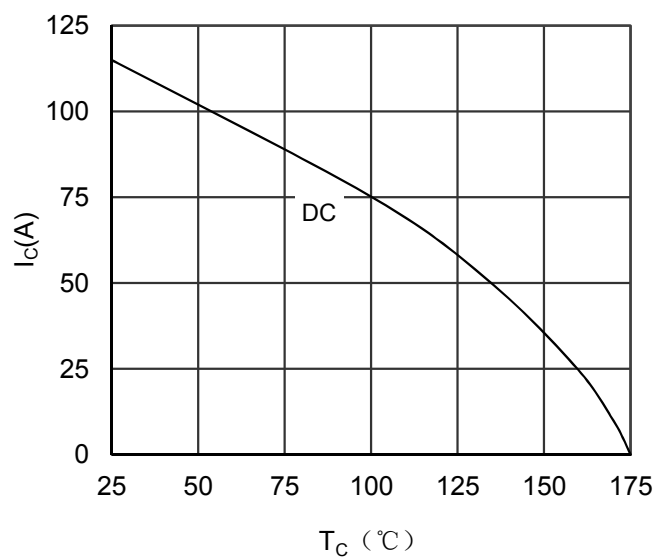

Figure 6. Collector Current vs Case temperature IGBT

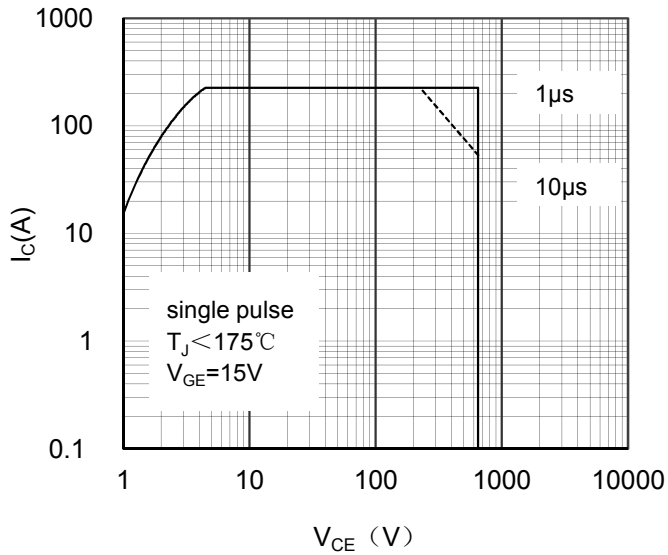

Figure 7. Forward Biased Safe Operating Area

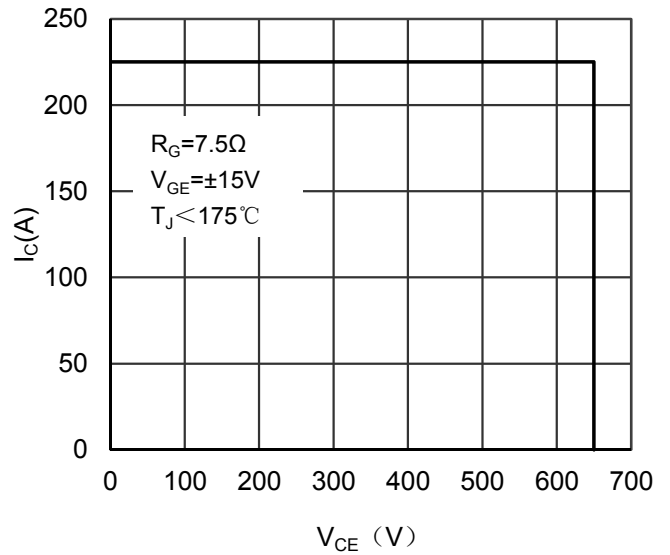

Figure 8. Reverse Biased Safe Operating Area IGBT

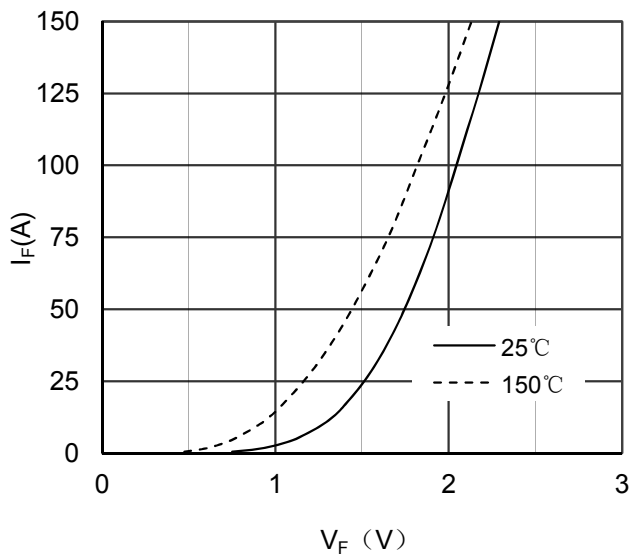

Figure 9. Diode Forward Characteristics Diode

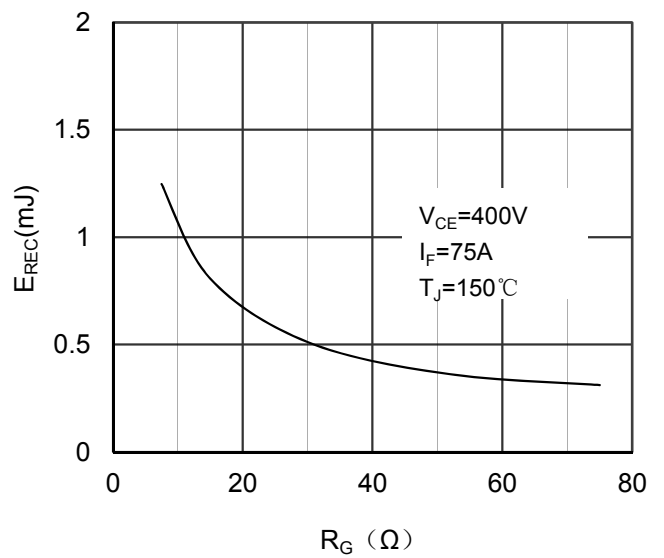

Figure 10. Switching Energy vs Gate Resistor Diode

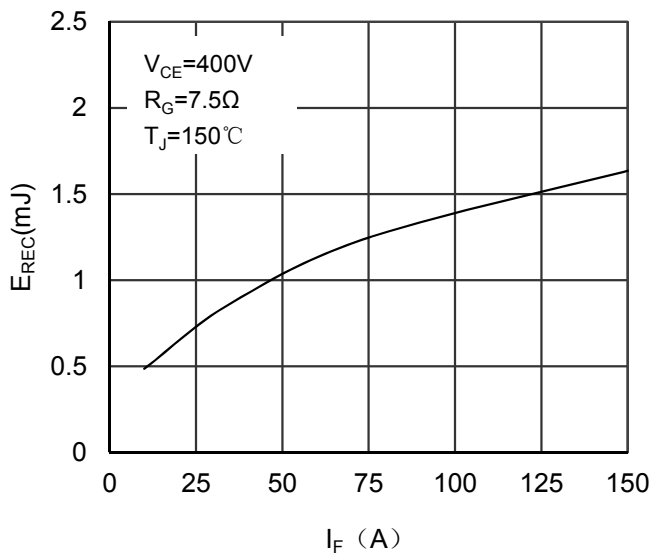

Figure 11. Switching Energy vs Forward Current Diode

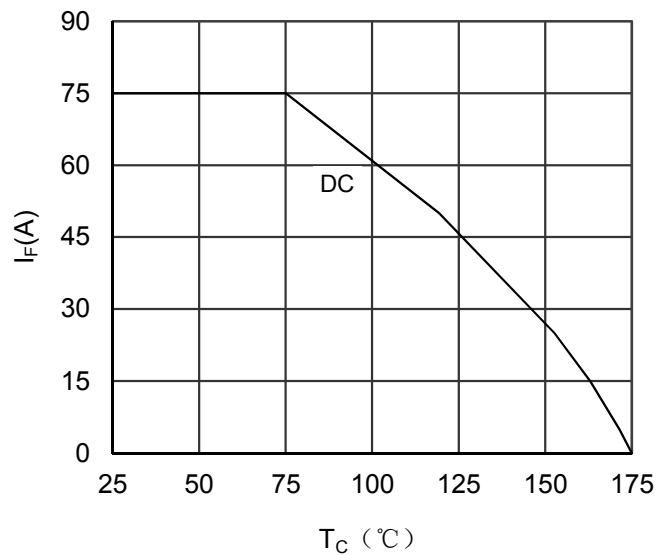

Figure 12. Forward current vs Case temperature Diode

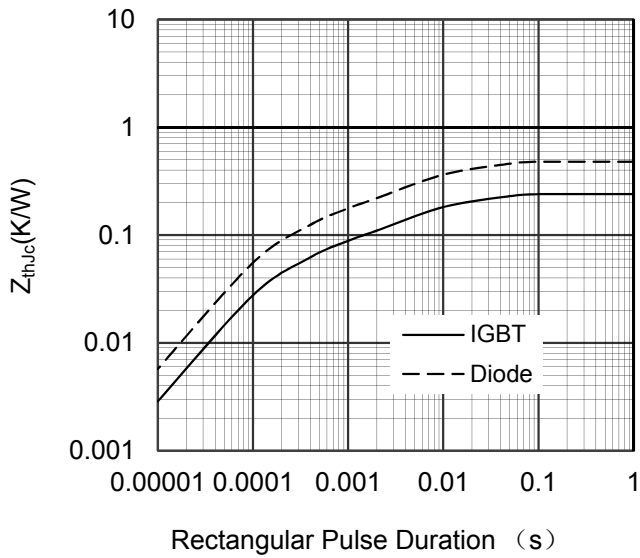
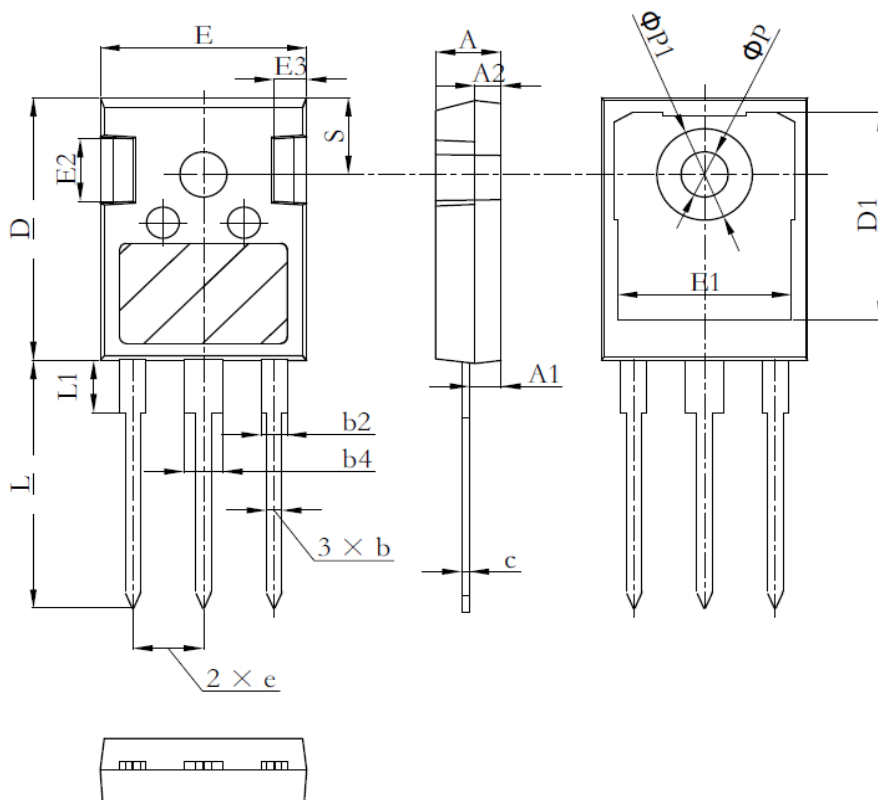

Figure 13. Transient Thermal Impedance of Diode and IGBT



Dimensions in (mm)  
Figure 14. Package Outline

Symbol	Min	Nom	Max
A	4.80	5.00	5.21
A1	2.21	2.41	2.61
A2	1.85	2.00	2.16
b	1.07	1.23	1.36
b2	1.90	2.05	2.41
b4	2.87	3.05	3.38
c	0.50	0.60	0.75
e	5.44BSC		
E	15.50	15.80	16.13
E1	12.38	13.30	13.60
E2	3.68	-	5.20
E3	1.00	-	2.70
D	20.70	21.00	21.30
D1	16.25	-	17.65
L	19.60	19.91	20.32
L1	-	-	4.40
ΦP	3.40	3.60	3.80
ΦP1	-	-	7.30
S	6.15BSC		

技术要求:

1. 单位: mm
2. 成品需符合RoHS2.0要求.